

APPLICATION

BODINE
ELECTRIC
COMPANY

note

a technical paper from Bodine Electric Company

How to Wire a New 3-Wire-Reversible WX or FX Permanent Split Capacitor AC Gearmotor into a 4-Wire System

1 STANDARD CONNECTION DIAGRAMS for stock 4-wire and 3-wire motors/gearmotors

Color coding and wire combinations vary between different product types. Connection diagrams and direction of rotation changes between gearmotors with odd and even numbers of gear stages within the same gearhead family. Please note that permanent split capacitor (PSC) motors and gearmotors require a run capacitor at all times. Capacitor specifications can be found on the motor nameplate and on our [web site](#).

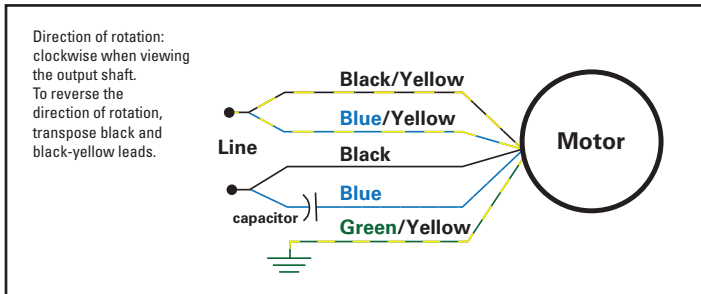

Connection Diagram 07410296: 4-Wire-Reversible

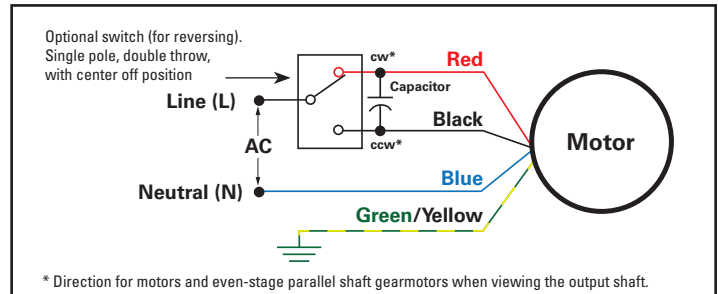

Connection Diagram 07410019: 3-Wire-Reversible

2 REVERSING APPLICATIONS: Connecting a 3-wire gearmotor to a 4-wire system

The schematic below shows how a 3-wire reversing PSC gearmotor/motor can be connected with the use of a relay to existing 4-wire PSC motor circuitry. The relay is required for reversing the direction of rotation of the 3-wire motor and in situations where the existing circuitry will not be modified. For 115 VAC motors, an Omron Industrial Automation relay, part number LY1-AC110/120 or equivalent can be used.

Instructions

1. Disconnect the lead wires of the old 4-wire motor or gearmotor and also remove the old motor capacitor. If the motor capacitor is part of the existing circuitry (and not mounted near the motor), then please locate and remove it prior to installing the new motor or gearmotor. The new 3-wire motor will require a different capacitor.
2. The required capacitor value for the new motor or gearmotor is listed on the motor's nameplate and on our [web site](#).
3. Connect the 3-wire-reversible motor, relay and new run capacitor as shown in Figure 2 below.

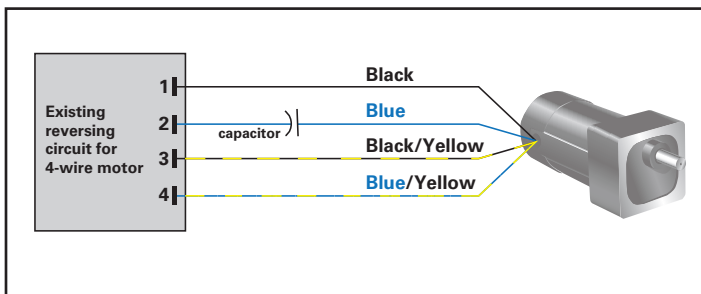

Figure 1: Four-wire reversing motor/gearmotor circuit

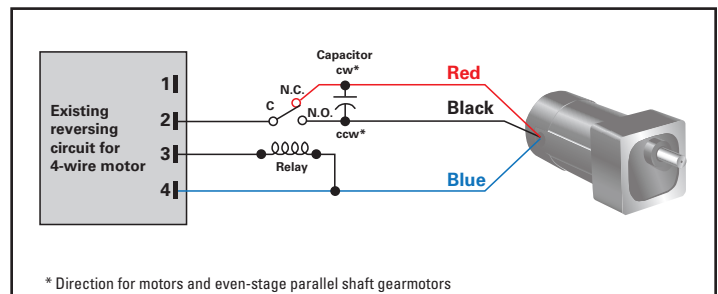

Figure 2: Three-wire reversing motor/gearmotor connection into an existing 4-wire set-up.

3 UNI-DIRECTIONAL APPLICATIONS: Connecting a 3-wire gearmotor to a 4-wire system

If the application is uni-directional (no reversing required) then no relay is needed to connect a 3-wire PSC gearmotor/motor to the original 4-wire hook-up.

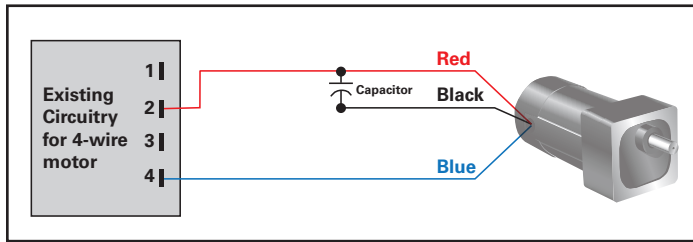

Figure 3: Three-wire non-reversing connection (clockwise direction of rotation when viewing output shaft)
 (for motors and even-stage parallel shaft gearmotors. Odd stage parallel shaft gearmotors will rotate in the opposite direction)

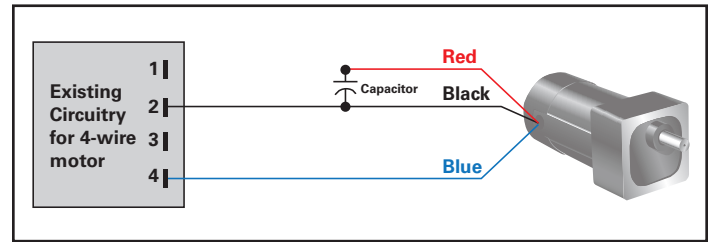
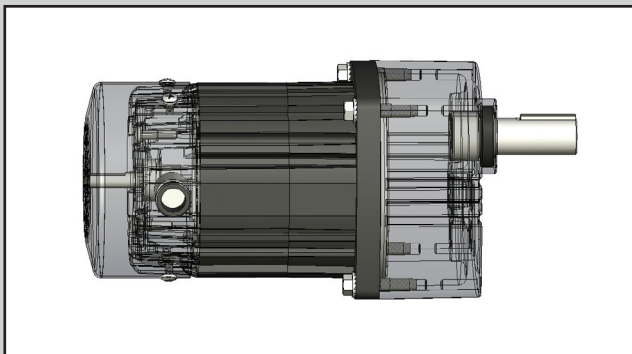

Figure 4: Three-wire non-reversing connection (Counterclockwise direction of rotation when viewing output shaft)
 (for motors and even-stage parallel shaft gearmotors.)

[Click here](#) for information about run capacitors for PSC AC stock motors and gearmotors.



Permanent Split Capacitor (PSC) Gearmotors and Motors

EXCERPT FROM THE *BODINE HANDBOOK*, CHAPTER 2

When split-phase or capacitor start (CS) motors are applied in applications that require long or frequent starts, the motor may tend to overheat and adversely affect the system reliability. In this type of application, PSC motors and gearmotors should be considered. The PSC capacitor winding is permanently connected in series with a continuous-duty "run" capacitor. In contrast to the split-phase or capacitor start motor, the "second" winding is energized at all times.

Permanent split capacitor motors operate in much the same way as two-phase AC motors. The capacitor in the PSC design causes the current in the capacitor winding to be out of phase (with respect to time) with the current in the main winding, thus a rotating magnetic field is created. This action gives the PSC motor greater efficiency and quieter, generally smoother

operation than the split-phase or the split-phase capacitor start designs.

Application Considerations: Since the phase angle in PSC motors changes with an increase in load, performance will usually be less satisfactory while starting. In usual design practice, a compromise must therefore be made between the starting and running modes. Changing the capacitor value specified by the manufacturer will affect both running and starting characteristics so that any improvements in starting will usually result in a decrease in running performance.

Caution: While an optimum capacitor value can enhance motor performance, an improper value of capacitance can decrease performance. It is, therefore, advisable to use the rated capacitor value recommended by the manufacturer (on the motor nameplate).

It should also be noted that PSC motors should be run at or near their rated load points. Unlike other motor types, PSC designs will tend to run hotter if lightly loaded or unloaded.

